

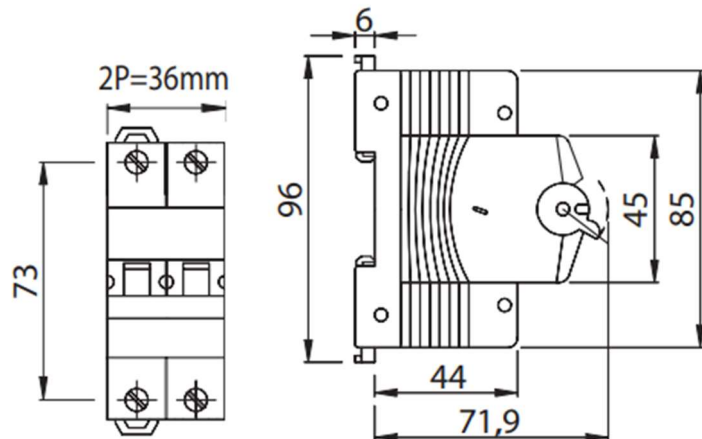

Modulær lastbryter
Antall poler: 2
Antall moduler: 2
Merkestrøm: 32A
Standard: AC-23B
Merkespenning: 240-415AC
Elnr: 1401324

Standard;	EN 60947-3	Frekvens (Hz)	50/60Hz
Merkestrøm (In)	32A	Isolasjonsspenning	500V
Slutte kapasitet	320A	Effekt tap pr pol	0,8W
Bryte kapasitet	256A	Skrutrekker	PZ2
Kortslutning strøm (Icw)	384A	Tiltrekningsmoment	2Nm
IP	20	Driftstemperatur	- 5 til + 40° C
		Nominell impulsstøtspenning	4kV
Tverrsnitt en leder kabel	≤ 1x35 - ≤ 2x16 - ≤ 1x16+2x10mm <sup>2</sup>	Tverrsnitt fleksibel kabel	≤ 1x35 - ≤ 2x16 - ≤ 1x16+2x10 mm <sup>2</sup>

### Dimensjon



### Standarder/godkjenninger

